

Corrigendum To Tender Enquiry
Government of Pakistan
Pakistan Ordnance Factories (Explosives)
Wah Cantt

Please read following amendment in the description of store:-

T.E. No. 0031-EXP-FP-48 & Date:15-03-2018		
T.E Sr #	Description of Store	
	For	Read
02	ACID RESISTANT BRICKS DIA : 900MM HEIGHT 1500MM for lining of dilute sulphuric acid collecting tank. (alongwith AR Cement Powder & Liquid) DRG# 8362-2-A	ACID RESISTANT BRICKS DIA : 900MM HEIGHT 1500MM for lining of dilute sulphuric acid collecting tank. (alongwith AR Cement Powder & Liquid) DRG#POF/E-33/01-S/27

2. All other terms and conditions will remain unchanged.

Date: 04 -04-2018.

Manager - Purchase (X)
POFs Wah Cantt.
Ph: 051-9055-29201, 29216
E-mail:-mdexp@pof.gov.pk



POF 1262
(FOREIGN SUPPLIES)

Government of Pakistan
PAKISTAN ORDNANCE FACTORIES
TENDER ENQUIRY

To

M/s .

Dear Sirs,

Reference : TENDER ENQUIRY NO. 0031/EXP/FP/48

DATED 15-MAR-18

You are requested to submit quotations for the items noted in the schedule to the tender. Offers should be sent duly sealed in an envelope. Please note the following instructions for filling the tender:-

1. SUBMISSION OF TENDER

1.1 Tenders will be opened at 12:30 hours on 30-APR-18 and must reach this office on or before 12:00 hours up to due date. The tender received late will not be entertained. You may witness the opening of the tender if you so desire. If a representative is deputed, he should bring a letter of authority from you.

1.2 Only one tender should be included in one envelope. The outside of the envelope should be inscribed with:-

Tender Enquiry No: 0031/EXP/FP/48

Tender to be opened on: 30-APR-18

Address as follows:-

MANAGER PURCHASE

EXPLOSIVES FACTORY

POF WAH CANTT

1.3 If envelope does not indicate reference of TEs or received late the same may be returned un-opened.

2. GENERAL INSTRUCTIONS REGARDING PREPARATION OF QUOTATIONS

2.1 For materials, the prices should be filled in column 5 and delivery date in column 6 of the schedule to this Tender Enquiry. The undertaking should be signed at the bottom of the Schedule which shall form the Quotation. You may use a separate sheet if necessary.

Contd.....P-2

2.2 For Plant and Machinery, you are required to quote in two parts:-

Part I "Technical Offer": It should exclusively give technical details and literatures/ brochures of the offered plant, machinery and equipment; validity date; delivery schedule; and signed undertaking given on the schedule to this Tender Enquiry. It must not indicate price, costs etc.

Part II "Commercial Offer": It should indicate the commercial terms e.g. price, terms of payment, mode of payment, mode of supply.

Each part should be placed in a separate sealed cover. The envelopes should be inscribed with: Part I "Technical Quotation without Price" and Part II "Commercial Quotation with Price".

2.3 The quotation must remain valid for, at least 90 days from the date of opening of tenders.

2.4 The quotation should hold good for any reduced or enhanced quantities without notice.

2.5 In the event of non-acceptance of offer, intimation may be given to the Tenderers on their request.

2.6 Conditional offers or alternative offers are likely to be ignored.

2.7 Quotations should be based on FOB. The consignment will be shipped through Pakistan National Shipping Corporation (PNSC). In case there is no PNSC service in the country of shipping, please quote on C & F basis. The freight should be indicated separately. Insurance premium should not be included in the quoted price. However, where insurance is considered necessary, advice to that effect should be given in the quotation.

2.8 Submission of the offer through an agent in Pakistan should be avoided. In case it is considered inevitable, the agent's quotation must invariably be accompanied by the original proforma invoice from the principals/manufacturers.

2.9 Country of origin and port of shipment to be stated

2.10 The offer of the principal must clearly indicate whether the rate quoted is inclusive of agent's commission, and if inclusive rate of commission included be specified.

2.11 Suppliers will render necessary information regarding hazardous effects on environment, of the materials/products supplied by them, in their quotations and shipping/despatch documents

2.12 If the requisite information is not furnished on the T.E form or offer received is not in conformity with the requirement of the T.E each offer shall be ignored.

3. INSPECTION

3.1 Supplies shall be subject to the inspection and acceptance by the competent inspection authority nominated by the Purchaser, who will arrange it at his own cost. Inspection facilities such as tools, test equipment, instruments etc will, however, be provided by the Suppliers in accordance with the relevant specifications.

3.2 Where considered necessary by the Purchaser, stores may be obtained on Warranty/Guarantee, subject to inspection on receipt. Rejected stores will be removed and replaced with the acceptable stores by the Supplier at his own expense, within a specified time.

3.3 TENDER SAMPLE

Where required offer must accompany tender sample strictly according to the description and specification given in Tender Enquiry. Offer not accompanied by tender sample will NOT be entertained excepting the established and reputable firms who have either previously satisfactorily supplied the same or similar stores or have submitted an acceptable sample thereof against previous T.E.

4. ACCEPTANCE OF OFFERS

4.1 POF may reject all bids or proposals at any time prior to the acceptance of a bid or proposals, but is not required to justify grounds for its rejection. POF shall incur no liability towards suppliers or contractors who have submitted bids or proposals.

4.2 PERFORMANCE BOND

(a) The successful bidder will provide Performance Bond at the rate up to 10% of F.O.B value of the contract in favour of Controller Military Accounts (CMA) POF Wah Cantt. The Performance Bond will be furnished in the form of Deposit At Call Receipt (CDR) from any scheduled bank in Pakistan or an unconditional bank guarantee on prescribed proforma covered by any scheduled bank in Pakistan. The performance Bond shall be furnished within 45 days from the date of opening of Letter of Credit. It shall be valid for a period of 12 months after the date of expiry of letter of credit. If the Performance Bond is not furnished within the prescribed time of 45 days, the Purchaser reserves the right to:

- i. Impose penalty @ 1% per month of the value of CDR/BG.
(Clause-42 (a i) is not applicable in case of procurement of Plant/Equipment/Machinery items).

OR

- ii. Cancel the contract and make other arrangements for purchase of the stores at the risk and expense of the Supplier.

(b) No Performance Bond will be required if the total FOB value of the contract is less than US \$50,000 and contract is placed directly on the foreign Supplier.

4.3 FAILURE TO SUPPLY THE STORES

All deliveries must be completed by the specified date. If the failure to deliver the stores within the scheduled time should have arisen from "Force Majeure", which the purchaser may admit as reasonable ground for further time, he will allow such additional time as he may consider to have been required by the circumstances of the case. Otherwise, he will be entitled, at his discretion, to cancel the contract; and/or, claim liquidated damages upto 2% but not less than 1% of the contract price of the items and their quantities for each and every month or part of a month, beyond the specified delivery date, during which these may not be delivered, subject to a maximum of 10% of the total contract value or, to purchase, from elsewhere, the unsupplied stores at the risk and cost of the supplier.

4.4 PAYMENT

Payment will normally be made by means of irrevocable letter of credit. Unless otherwise stated 90% payment will be released on submission of despatch documents to Bank while balance 10% payment will be released on receipt and acceptance of store by the consignee.

All Bank charges incurred in Pakistan in connection with the establishment of L.C. will be borne by the Purchaser, whereas all Bank charges incurred in connection with drawing of payment including charges for confirmation of L.C. by the advising Bank/Foreign Bank will be borne by the Supplier.

5. SECURITY OF INFORMATION

The tenderer and his employees must not communicate any information relating to the sale/purchase of stores under this enquiry to any person other than the manufacturer or to any press or agent not authorised in writing by POFs to receive it.

Please return the Schedule to the Tender duly signed by the specified date, alongwith the specifications, drawings etc., if any, enclosed herewith - even if you are unable to quote.

WARNING In case the firm abstain from making offers or fail to return/acknowledge the tender form by the specified date on three consecutive occasions, no further tender enquiry may be issued to them and their names would liable to be removed from the approved list.

Yours Faithfully

(MUHAMMAD AHMAD ARSALAN
MANAGER PURCHASE (X)
for PAKISTAN ORDNANCE FACTORIES

Tele 0092-51-9055-29216

Fax 0092-51-9271400

Telex 5840 POFAC PK

URGENT

PAKISTAN ORDNANCE FACTORIES WAH CANTT**SCHEDULE OF STORE TO BE SUPPLIED AGAINST T.E. NO. 0031-EXP-FP-48, DT. 15-03-2018.**

Sr. #	DESCRIPTION OF STORE	Unit	Qty	Price per Unit FOB or C&F		DELIVERY period
				In word	in figure	
1.	ACID RESISTANT BRICKS DIA : 2984MM, HEIGHT 2500MM for lining of dilute sulphuric acid collecting tank. (alongwith AR Cement Powder & Liquid) DRG# POF/E-33/01-S/29	Set	02			05 months after opening of L.C
2.	ACID RESISTANT BRICKS DIA : 900MM HEIGHT 1500MM for lining of dilute sulphuric acid collecting tank. (alongwith AR Cement Powder & Liquid) DRG# 8362-2-A	Set	02			

2. For Plant & Machinery:**Specification****3. Special conditions:**

- i. **Quotation must give detail of Bricks + AR Cement Powder + Liquid to be supplied in order to complete the above mentioned sets.**
- ii. Offer should be followed by proper and original Proforma Invoice.
- iii. Offer should clearly indicate the country of origin and port of shipment.
- iv. An assurance in your offer will be required that you have export license from your government for export of tendered store.
- v. Any quantity of store, if found defective functionally will essentially be replaced by the supplier free of cost under his own arrangements. All port and transportation charges related to rejected store will be paid or recoverable from supplier.
- vi. The store must be protected adequately and appropriately against damages from environmental effects, water or other substances during journey/transportation to withstand the rough handling involved in the transit and provide preservation of store while held in the storage by the supplier.
- vii. Moreover, all the terms and conditions given in T.E general instructions Proforma form POF 1262 (foreign supplies) must be accepted.
- viii. Store will be procured on warranty / guarantee basis, as per POF format.
- ix. No fax or e-mail offer will be accepted
- x. Supplier must accept all the terms & conditions embodied in form POF 1282 (General conditions of contract)
- xi. In case of no previous dealing/established business relations with your firm we prefer 100 % payment after receipt and acceptance of the store by the consignee through L/C.
- xii. Performance bond should be furnished positively within 45 days from the date of opening of letter of credit in the shape of bank guarantee @ 10% of FOB value of contract, if value of order exceeds US\$ 50,000/-
- xiii. **In case of local suppliers Tender fee for Rs.500/ in shape of cross postal order/pay order & Bid money in the shape of CDR/Pay Order/Banker's Cheque @ 2% (From registered supplier) & @ 5% (From un-registered supplier) of the quoted value in favour of M.D-Explosives , must be attached with the quotation, otherwise offer will not be entertained/considered.**

4. UNDERTAKING

Should our offer be accepted we hereby undertake to supply the stores/render the services contracted on the basis of conditions of contract embodied in form P.O.F.-1282 and to deposit the performance bond within the prescribed time, failing which it will constitute a breach of contract. and P.O.F. will have the right to purchase the stores/services elsewhere at our risk and cost.

PLACE.....

DATED.....

SIGNATURE OF THE TENDERER

NAME:.....

POSITION.....

INCOME TAX/ G.I.R. NO.....

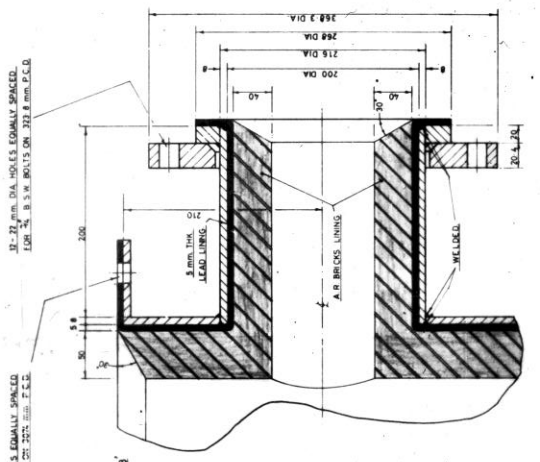

ENLARGED DETAIL OF BRANCH 'A'
SCALE 1:2

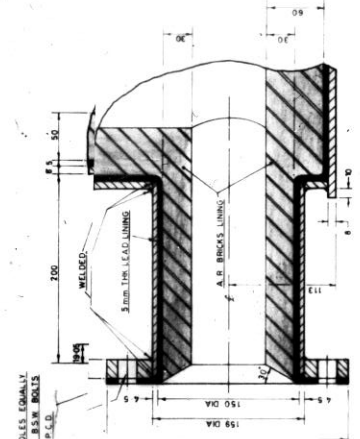

ENLARGED DETAIL OF BRANCH 'B'
SCALE 1:2

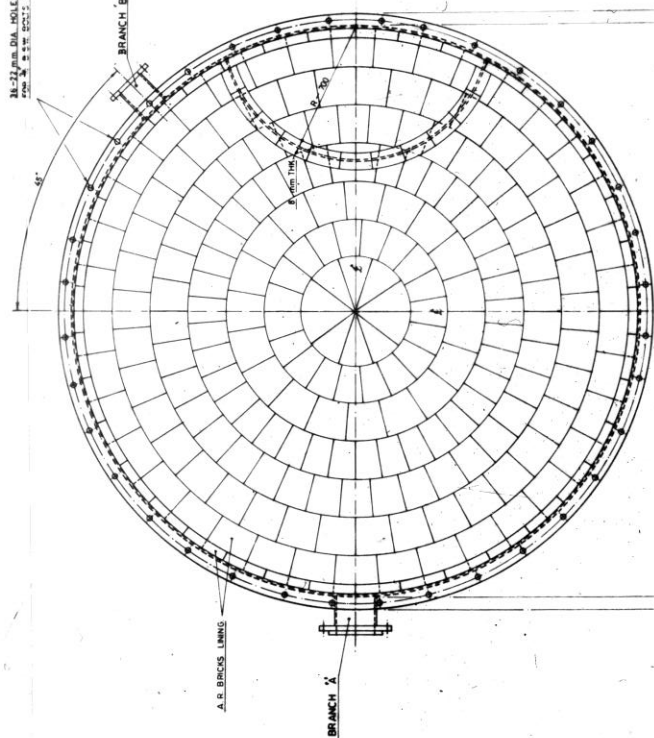

PLAN
SCALE 1:10

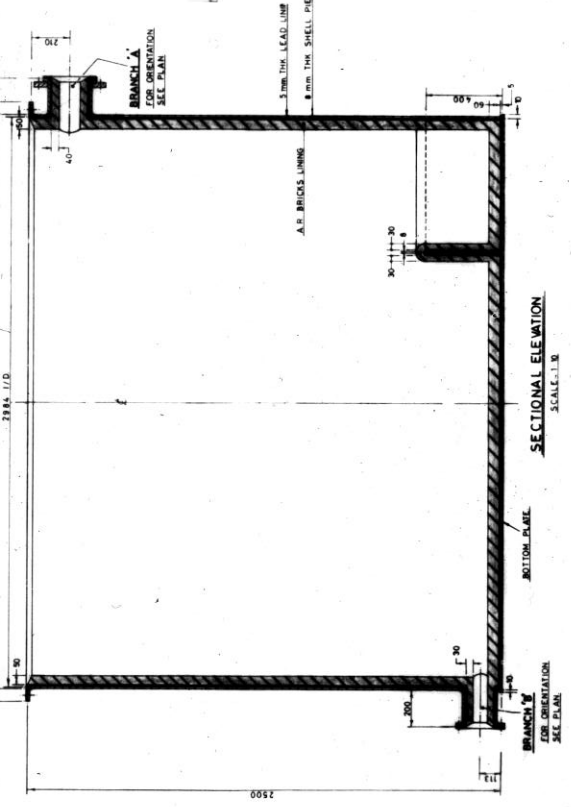

SECTIONAL ELEVATION
SCALE 1:10

NOTES:

- 1 FIGURED DIMENSIONS ARE TO BE FOLLOWED
- 2 ALL DIMENSIONS ARE IN MILLIMETRES
- 3 MATERIAL TO BE HYDROGEN BOND LEAD LINED
- 4 MATERIAL TO BE HYDROGEN BOND LEAD LINED
- 5 SHELL IN S. LINING - CHEMICAL LEAD & ACID RESISTANT BRICKS
- 6 OPERATING CONDITION
- 7 STORAGE OF DILUTE SULPHURIC ACID 85-10% STRENGTH AT TEMPERATURE 15°C.

TITLE:- A.R BRICKS LINING IN D.O.V COLLECTING TANK

DRG. No. POF/E-33/01-S/29

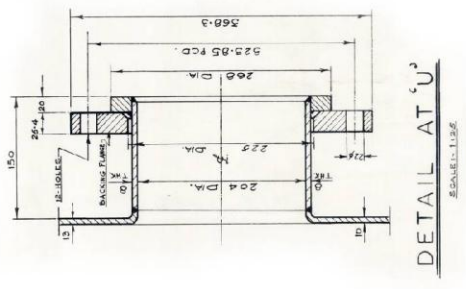
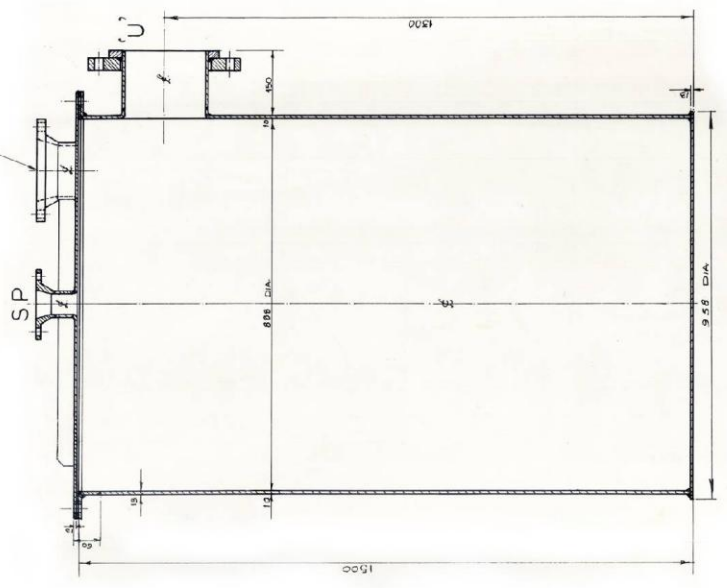
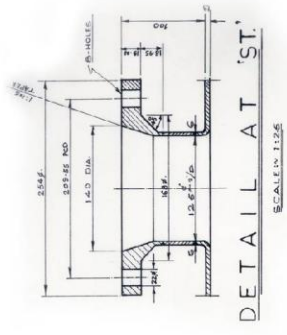
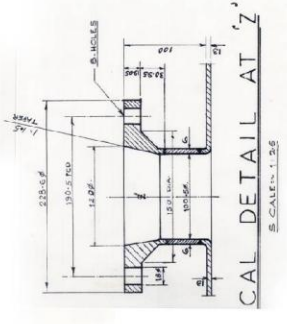
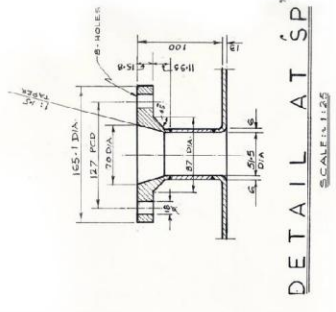
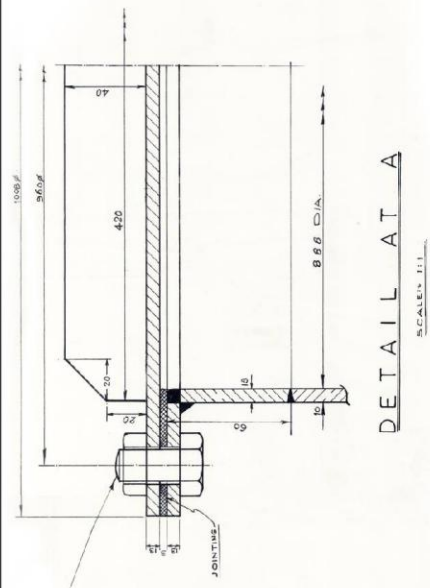
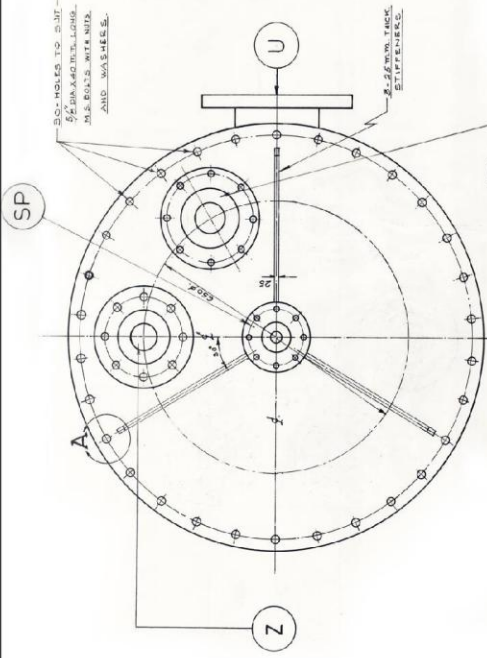

NOTES

1- FIGURED DIMENSIONS ARE TO BE FOLLOWED

2- ALL DIMENSIONS ARE IN MILLIMETERS

3- MATERIAL IS M.S.

SECTIONAL ELEVATION
SCALE 1:1.25

TITLE: DETAIL OF D.O.V COLLECTOR
DRG. No. POF/E-33/01-S/27