

GOVERNMENT OF PAKISTAN
PAKISTAN ORDNANCE FACTORIES
TENDER ENQUIRY

To

M/s _____

Dear Sirs,

Reference: TENDER ENQUIRY NO. 0190/GDL/LP/47/Pur, DATED 12.10.2017.

You are requested to submit quotations for the item (s) noted in the Schedule to the Tender. Offer should be sent duly sealed in an envelope. Please note the following instructions for filling the tender:-

1. **SUBMISSION OF TENDER.**

1.1. Tenders will be opened at 1230 hours on **31-10-2017** and must reach this office on or before 1200 hrs upto due date. The tender received late will not be entertained. You may witness the opening of the tender if you so desire. If a representative is deputed, he should bring a letter of authority from you.

1.2. Only one tender should be included in one envelope. The outside of the envelope should be inscribed with: -

Tender Enquiry No: 0190/GDL/LP/47/Pur, DATED 12-10-2017

Tender to be opened on: 31-10-2017 at 1230 Hours

Address as follows:-

Managing Director POF Gadwal,
Sub Post Office 26 Area Gadwal
Wah Cantt Teh. Taxila Distt. Rawalpindi

1.3. If envelope does not indicate reference of T.E or received late the same may be returned un-opened.

2. **GENERAL INSTRUCTIONS REGARDING PREPARATION OF QUOTATIONS**

2.1 For materials, the prices should be filled in column 5 and delivery date in column 6 of the schedule to this Tender Enquiry. The undertaking should be signed at the bottom of the schedule, which shall form the Quotation. You may use a separate sheet if necessary.

2.2. For plant and Machinery, you are required to quote in two parts:-

Part I "Technical offer": It should exclusively give technical details and literatures/brochures of the offered plant, machinery and equipment; validity date; delivery schedule; and signed undertaking given on the schedule to this Tender Enquiry. It must not indicate price, costs etc.

Contd P/2

-:2:-

Part II “Commercial offer” It should indicate the commercial terms e.g. price, terms of payment, mode of payment, mode of supply.

Each part should be placed in a separate sealed cover. The envelopes should be inscribed with: Part I “Technical Quotation without price” and Part II “Commercial Quotation with price.”

- 2.3 The quotation must remain valid for, at least 90 days from the date of opening of tenders.
- 2.4 The quotation should hold good for any reduced or enhanced quantities without notice.
- 2.5 In the event of non-acceptance of offer, intimation will be given to the Tenderers on the their request.
- 2.6 Conditional offers or alternative offers are likely to be ignored.
- 2.7 Quotations should be based on:-

F.O.R. station of despatch basis, i.e. delivered free on rail, inclusive of packing and forwarding charges. The stores will be booked under Military Credit Note, to be provided by the purchaser. and/or Free delivery at POF’s store at **POF Gadwal Wah Cantt** in this case octroi duty will be payable by the supplier.

2.8 Taxes and Duties etc. where applicable must be shown separately, quoting reference to Registration No. in cases of Sales Tax and relevant authority in the case of others. Offer without these clarifications and inclusive of Taxes and Duties may be ignored.

2.9 Taxes and duties levied on or after Tender opening date or on or after the date offer was signed and despatched will be allowed to include in the offered rates.

2.10 "Suppliers will furnish a certificate, issued by Excise & Taxation Deptt., that he has cleared all Professional tax payable by him". Offers received without this certificate will be rejected.

2.11 Suppliers will render necessary information regarding hazardous effects on environment, of the materials/products supplied by them, in their quotations and shipping/despatch documents.

2.12 If the requisite information is not furnished on the T.E. Forms or offer received is not conformity with the requirement of the T.E. such offer shall be ignored.

3. INSPECTION

3.1 Supplies shall be subject to the inspection and acceptance by the competent inspection authority nominated by the Purchaser, who will arrange it at his own cost. Inspection facilities such as tools, test equipment, instruments etc will, however, be provided by the Suppliers in accordance with the relevant specifications.

3.2 Where considered necessary by the Purchaser, stores may be obtained on Warranty/Guarantee, subject to inspection on receipt. Rejected stores will be removed and replaced with the acceptable stores by the Supplier at his own expense, within a specified time.

Contd P/3

-:3:-

4. TENDER FEE

The tender must be accompanied by a non-refundable fee by means of a crossed postal order/pay order of Rs.500/- in favour of **Director Admin POFs Wah Cantt.**

4.1 TENDER SAMPLE

Where required, offer must accompany tender sample, strictly according to the description and specification given in Tender Enquiry. Offer not accompanied by tender sample will NOT be entertained excepting the established and reputable firms who have either previously satisfactorily supplied the same or similar stores or have submitted an acceptable sample thereof against previous T.E.

5. BID MONEY

- 5.1 Bid Money at the rate of 2% (for registered firms) and 5% (for unregistered firms) of the quoted value should accompany the tender in the shape of Deposit At Call Receipt/Pay Order/Banker's Cheque, from a Scheduled Bank drawn in favour of:-

G.M-PP&C-POF-Gadwal, Wah Cantt.

Tenders received without Bid Money will be rejected.

- 5.2 Bid Money of the unsuccessful tenderers will be returned as soon as the scrutiny of the tenders is completed. Bid Money of the successful tenderers will be retained until the contract is finalized. Bid Money will be forfeited in case the quotation is withdrawn before the expiry of its validity date.

- 5.3 State owned organizations are not required to provide Bid Money.

6. ACCEPTANCE OF OFFERS

- 6.1 POF may reject all bids or proposals at any time prior to the acceptance of a bid or proposals, but is not required to justify grounds for its rejection. POF shall incur no liability towards suppliers or contractors who have submitted bids or proposals.

6.2 PERFORMANCE BOND

(a) The successful bidder shall provide Performance Bond which shall not exceed 10% of contract value in the form of Deposit At Call Receipt from any scheduled bank; or, an un-conditional Bank Guarantee valid for 12 months (03 months extendable to 12 months in case of cloth items required by Clothing Fy) after receipt of store in POF on a prescribed format. The performance bond will be in favour of C.M.A. POF Wah Cantt. It will be returned on satisfactory completion of the contract.

(b) If the supplier fails to furnish the Performance Bond within the specified time, such failure will constitute a breach of the contract and the Purchaser shall be entitled to make the other arrangements for purchase of the stores at the risk and expense of the supplier.

Contd P/4

-:4:-

6.3 Performance bond from state owned organizations may be waived off at the discretion of the purchaser.

6.4 FAILURE TO SUPPLY THE STORES.

All deliveries must be completed by the specified date. If the failure to deliver the stores within the scheduled time should have arisen from "Force Majuro", which the Purchaser may admit as reasonable ground for further time, he will allow such additional time as he may consider to have been required by the circumstances of the case. Otherwise, he will be entitled, at his discretion, to cancel the contract; and/or, claim liquidated damages upto 2% but not less than 1% of the contract price of the items and their quantities for each and every month or Part of a month, beyond the specified delivery date, during which these may not be delivered, subject to a maximum of 10% of the total contract value of the particular stores which remained unsupplied either in part or in full: or, to purchase, from elsewhere, the unsupplied stores at the risk and cost of the Supplier.

6.5 PAYMENT.

(a) Payment will be made by the CMA(POF) through crossed cheque on receipt/acceptance of store on our prescribed bill form supported by receipt voucher on part/full supply basis.

(b) Payment of duties/Taxes including professional tax (where applicable) must be supported by proof of having paid these to concerned Govt. Taxation Deptt.

7. SECURITY OF INFORMATION.

The tenderer and his employees must not communicate any information relating to the sale/purchase of stores under this enquiry to any person other than the manufacturer or to any press or agent not authorized in writing by POFs to receive it.

Please return the Schedule to the tender duly signed by the specified date, alongwith the specifications, drawings etc. if any, enclosed herewith - even if you are unable to quote.

WARNING In case the firm abstain from making offers or fail to return/acknowledge the tender form by the specified date on three consecutive occasions, no further tender enquiry will be issued to them and their names would be liable to remove from approved list.

Yours faithfully,

(MUHAMMAD MASOOD)
GM-PP&C-POF GADWAL
For PAKISTAN ORDNANCE FACTORIES

Tele No.0092-051-9314096-98,

Fax No. 0092-051-9314099,

PAKISTAN ORDNANCE FACTORIES

SCHEDULE TO TENDER NO.0190/GDL/LP/47/Pur, DATED 12-10-2017.

1. FOR MATEIRALS.

(1)	(2)	(3)	(4)	(5)	(6)
Item No.	Description with Spec. etc.	Unit.	Qty.	Quoted Price per Unit In figure ! In words	Delivery Date
i)	Disc Drg. No.GDL/RAAD-EC/C-52.	Nos	910	! ! ! ! ! !	Within (03) months after placement of contract duly inspected/accepted by CIA Rawalpindi.
ii)	Packing Container for Expelling Charge Assembly Rocket 73MM RA'AD & H.E Drg. No. SK/GDL/COM-904.	Nos	325	! ! ! !	-do-

(2) For Plant & Machinery:

Specifications.

(3) Special Conditions:-

- i) Only registered suppliers (with Sales Tax & Income Tax Deptt) who are on Active Tax Payer List (ATL) of FBR are eligible to supply goods/services to Government Departments.
- ii) The Payment to registered persons shall be linked with the Active Tax Payer status of the suppliers as per FBR database. If any registered supplier is not in ATL his payment should be stopped till he files his mandatory returns and appears on ATL of FBR.
- iii) **Inspection Authority:- C.I.A - Rawalpindi.**
- iv) Offers of the National Bidders will be entertained only.
- v) Fax offers, e.mail offers and offers with less Bid Money and without Tender Fee will not be entertained.
- vi) For further details/queries please contact through e-mail mdgdl@pof.gov.pk

4) Undertaking.

Should our offer be accepted, we hereby undertake to supply the stores/tender the services contracted on the basis of General Conditions of Contract embodied in Form POF 1281, and to deposit the performance bond within the prescribed time, failing which it will constitute a breach of contract and POF will have the right to purchase the stores/services elsewhere at our risk and cost.

Place _____

Date _____

Signature of the Tenderer _____

Name _____

Position _____

Address _____

Income Tax G.I.R. No. _____

112

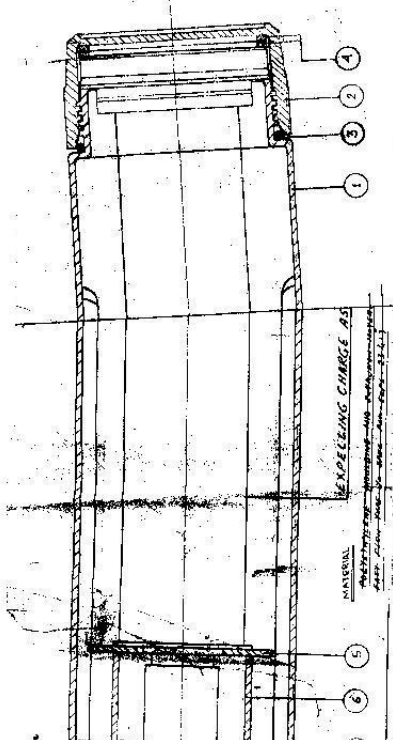

QTY	DESCRIPTION	UNIT	REMARKS
1	CONTAINER, PLASTIC	SEE DRG	
1	CAP CONTAINER	SEE DRG	
1	RUBBER SEAL	SEE DRG	
1	RING COMPRESSING	SEE DRG	
1	SPACER I	SEE DRG	
1	DISC LOCKING	SEE DRG	
1	DISC	SEE DRG	
1	SPACER II	SEE DRG	

Revised by [Signature]
 (Placed in [Signature])
 18 OCT 44

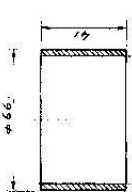

MATERIAL
 GRADED - GRADED DEF. A-A
 LEAD - DEF. A-A
 DIMS ROUNDED TO SPEC. REQUIREMENTS

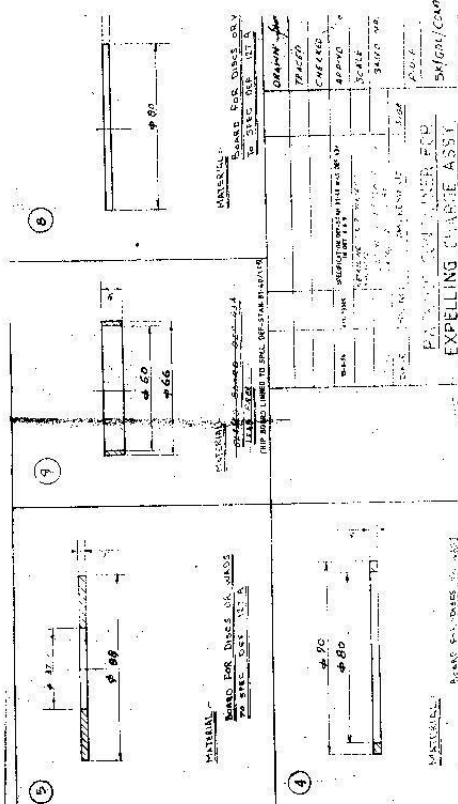
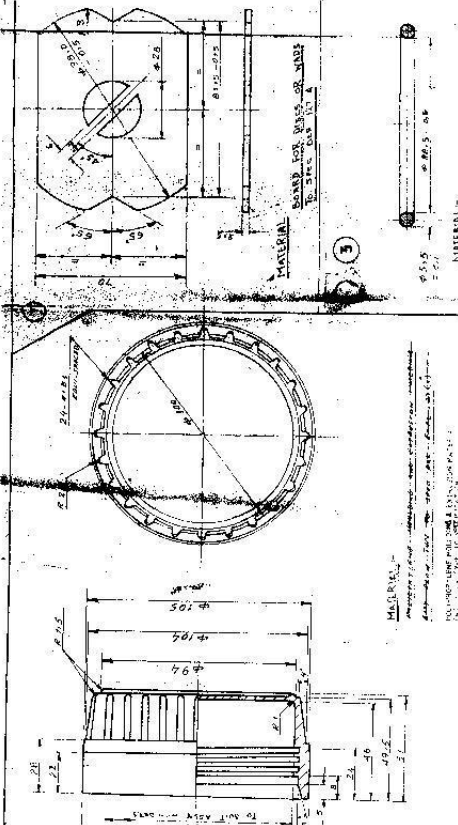
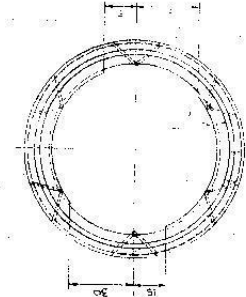
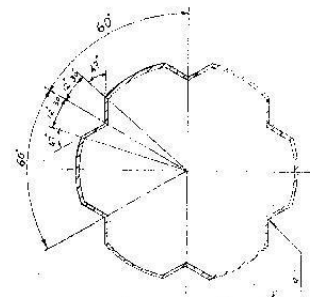
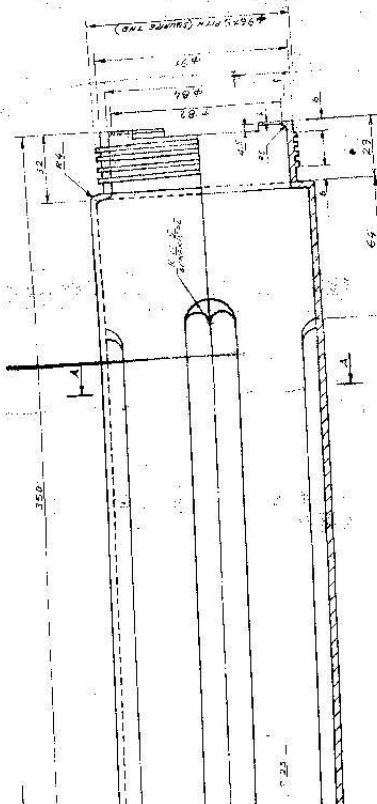

MATERIAL
 BOARD FOR DISC OR WARE
 TO SPEC. DEF. 132-A

MATERIAL
 BOARD FOR DISC OR WARE
 TO SPEC. DEF. 132-A

MATERIAL
 BOARD FOR DISC OR WARE
 TO SPEC. DEF. 132-A

MATERIAL
 BOARD FOR DISC OR WARE
 TO SPEC. DEF. 132-A

MATERIAL
 BOARD FOR DISC OR WARE
 TO SPEC. DEF. 132-A

MATERIAL
 BOARD FOR DISC OR WARE
 TO SPEC. DEF. 132-A

MATERIAL
 BOARD FOR DISC OR WARE
 TO SPEC. DEF. 132-A

MATERIAL
 BOARD FOR DISC OR WARE
 TO SPEC. DEF. 132-A

MATERIAL
 BOARD FOR DISC OR WARE
 TO SPEC. DEF. 132-A

MATERIAL
 BOARD FOR DISC OR WARE
 TO SPEC. DEF. 132-A

EXPPELLING CHARGE ASSY

EXPPELLING CHARGE ASSY

EXPPELLING CHARGE ASSY

EXPPELLING CHARGE ASSY

EXPPELLING CHARGE ASSY

EXPPELLING CHARGE ASSY

EXPPELLING CHARGE ASSY

GDL/RA/D-EC-C-52



CL

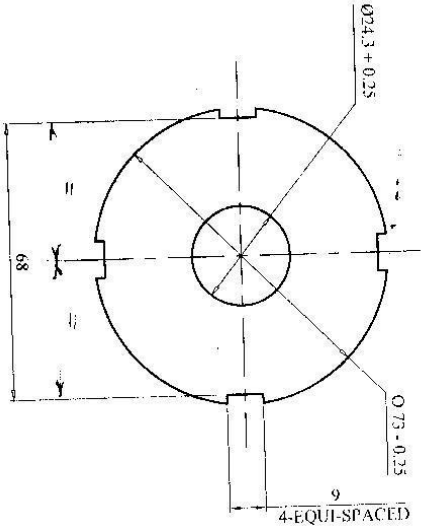

Prepared By: *[Signature]*
 Checked By: *[Signature]*
 Approved By: *[Signature]*
 Date: *12 May 12*

NOTE:-
 -ALL DIMENSIONS ARE IN MM
 -UNSPECIFIED TOLERANCES
 ACCORDING TO DIN 7188 (MEDIUM)

NO PER ROCKET	3	SCALE	NIS
Prepared By	POF GADWAL	Checked By	<i>[Signature]</i>
Approved By	<i>[Signature]</i>	Material Approval	AM
MATERIAL	CELLULOID SHEET TRANSPARENT TYPE OX TO SPEC. DEF. STAN 93 - 23 ISSUE 1		
SURFACE TREATMENT			
DRG. No.	GDL/RA/D-EC-C-52		
TITLE	DISC 73 MM HEAT ROCKET		
MOD. NO.	DATE	AMENDMENT	BY